

## 1.8KW HK-H Series Charger

### 1. Overview

HK-H series 1.8KW charger was specially designed, by Hangzhou Tiecheng Info&Tech Co., Ltd for supplying the electricity for electric vehicle's power battery, on the basis of the national standards for the charger. This product has the advantages of not only high efficiency, small size, high stability, long lifespan, but also high protection grade, and high reliability and complete protection function, etc. It's definitely an ideal charging power supply for electric vehicles.

This charger has built-in heat-sensing device and can automatic recover through the thermal protection. Fully sealed potting process and up to IP67 protection level ensures no causing trouble in any complex environment.

#### Key Features:

Fully sealed potting process, water cooling ( modular optional)	Work reliably under -35°C- +85°C
Built in thermal sensor	Cut off output under dangerous operations conditions (internal 95°C)
Protection level IP67	Work safely in the short-term immersion conditions

### 2. Model

Hardware	Output Voltage Range	Max Output Current	Lead Acid Battery Charger Model	Lithium Battery Charger Model
48V25A	18-68VDC	25A	HK-H-48-25	HK-H-H66-25
72V25A	25-99VDC	25A	HK-H-72-25	HK-H-H99-25
96V16A	34-132VDC	16A	HK-H-96-18	HK-H-H132-16

### 3. Features

Input	Frequency	45-65Hz
	Stand-by Consumption	≤5W
Main Output	Output Mode	CV / CC
	Output Power	<a href="#">1800W@220VAC</a> 700W@110VAC
	CV Accuracy	±1%
	CC Accuracy	±2%
Communication Function	Ripple Voltage Coefficient	5%
	CAN Communication	Yes
	Baud Rate	125Kbps、250Kbps、500Kbps
	Terminal Resistance	N/A
12V Output		Load Capacity of 200 mA, Output controllable

#### 12V5A (Optional Output Function)

Low Voltage Output	Output Mode	Constant Voltage
	Output Voltage	13.8V
	Rated Current	5A
	CV Accuracy	±2%
	Maximum Current	5.5A±0.5A
	Output Power	≥62.5W
	Ripple Voltage Coefficient	1%

### 4. Protection function

Input Over-voltage Protection	AC270±5V
Input Under-voltage Protection	AC85±5V
Output Over-voltage Protection	Stop the output when exceeds + 1% of the maximum output voltage
Output Under-voltage Protection	Stop the output when below -5% of the minimum output voltage

Output Over-current Protection	Stop the output when exceeds + 1% of the maximum output current
Over-temperature Protection	Power down from 85 °C and turn off at 90°C
Short-circuit Protection	Stop Output
Battery Reverse Connect Protection	Fuse Burn-out
Ground Protection	≤100mΩ
CAN communication Protection	Automatically stop the output when CAN communication fails
Power-off Protection	Yes

### 5. Safety and others

Withstand Voltage	Input to Output: 2000VAC≤10mA Input to Ground: 2000VAC≤12mA Output to Ground: 2000VAC≤10mA, all 1min
Insulation Resistance	Input, output, signal terminal to casing ≥10MΩ Testing Voltage 1000VDC
Electromagnetic Immunity	GB/T 18487.3-2001 11.3.1
Electromagnetic Abusive	GB/T 18487.3-2001 11.3.2
Harmonic Current	GB 17625.1-2003 6.7.1.1
Inrush Starting Current	≤24A
Current-rise Time	≤5S, Overshoot≤5%
Close Response time	100%到 10%≤50mS, 100%到 0%≤200mS
Protection Level	IP67
Vibration Resistance	10—25Hz Amplitude1.2mm, 25—500Hz 30m/s <sup>2</sup> , 8hrs per direction
Noise	≤60dB(A Level)
MTBF	15000H
Work Environment	Relative Temp 5%-95% No condensation
Working Temperature	-35°C ~ +85°C
Storage Temperature	-55°C ~ +100°C

ADD: 5/F, A, NO 108 , Xiangyuan Road, Hangzhou, China, 310015

### 6. Installation size, label requirements and interface definitions

#### 1). Installation size, Label

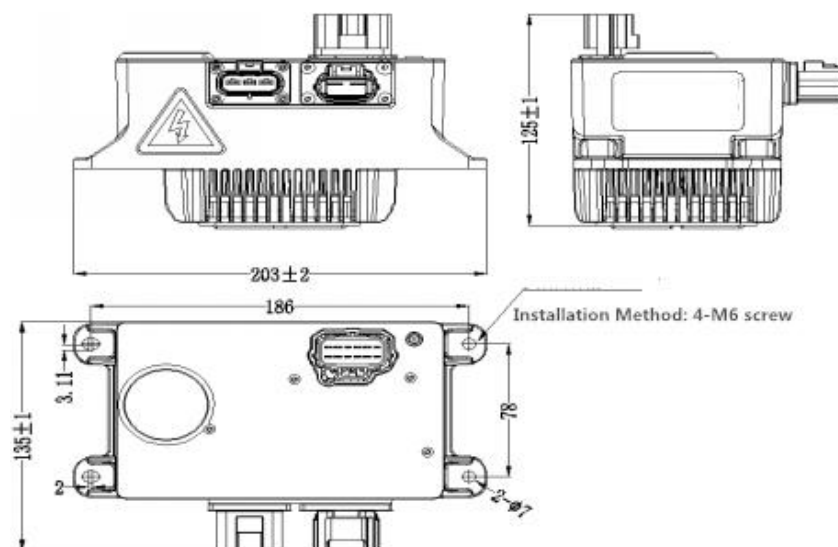

NET:3kg

#### Label ( based on the actual situation

<b><a href="http://www.tccharger.com">www.tccharger.com</a></b>	
Model:	HK-H-XXX-XX
Configuration:	XXCANXXXX/X-XXX
AC Input:	90-265VAC; 50/60Hz; 9A
DC Output:	XXXVXXA@220V
CAN ALG:	CAN XXXX
	 SNXXXXXXXXXX

2) . Interface Definitions

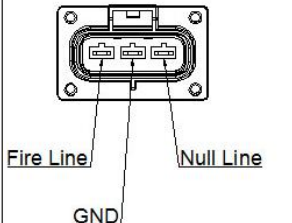
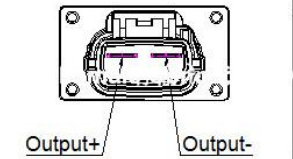
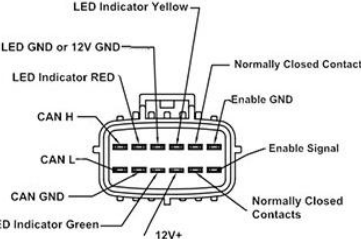
Input NO.: DJ7031-4.8-11	Output NO.: DJ7021-8-11	Signal NO.: DJ7124-2-11
 <p>Fire Line Null Line GND</p> <p>Female Connector NO.: DJ7031-4.8-21</p>	 <p>Output+ Output-</p> <p>Female Connector NO.: DJ7021-8-21</p>	 <p>LED Indicator Yellow LED GND or 12V GND LED Indicator RED CAN H CAN L CAN GND LED Indicator Green 12V+ Enable GND Enable Signal Normally Closed Contacts</p> <p>Female Connector NO.: DJ7124-2-21</p>

Notice: 1. The function on the signal connector are optional. It's not all available in the charger. e.g.CAN BUS control and Enable control cannot be existed at same time.

2. Pls pay attention to the position of function on the connector, don't pay attention to the numbers on the connector.[Enable wiring pin is at opposite of LED. CAN Wiring pins is close to LED.]

7. LED status

1). Initial State

Red Off Green Off Red Off Green Off Red Off Green Off Red Off Green Off

2). Charging State

Red Off Red Off Red Off Red Off Red Off Red Off Red Off Red Off

3). Stand-by State

Green Off Green Off Green Off Green Off Green Off Green Off Green Off Green Off

4). Fault State

Red Green Red Green.....Other error status word error

Red Green.....Wrong Battery

Red Green Red.....Wrong Communication

ADD: 5/F, A, NO 108 , Xiangyuan Road, Hangzhou, China, 310015

Red Red Green Green.....Wrong Enable

Green Red.....Wrong Input Voltage

Green Red Green.....Internal Temperature Protection

Green Red Green Red.....Wrong Hardware

8. Charging Curve

1). CC/CV Charging mode: (for Lithium Battery)

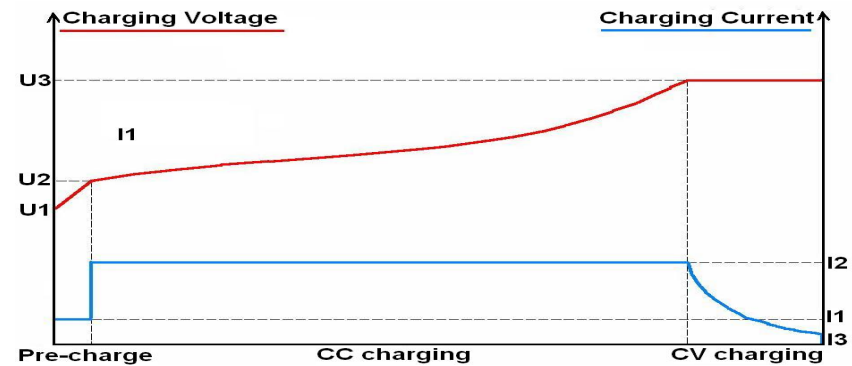

$U1 = \frac{U3}{2}$ ,  $U2 = n_{\#} \times 2.5V$ ,  $U3 = \text{Maximum voltage for the battery pack}$

$I1 = \frac{I2}{2}$ ,  $I2 = \text{Maximum charging current for the battery pack}$ ,  $I3 = \frac{I2}{6}$

① Pre-charge: It only enters into pre-charging process when the battery pack voltage is under  $U2$  ( The charger does not start when battery pack is under  $U1$ ), then it operates in a constant

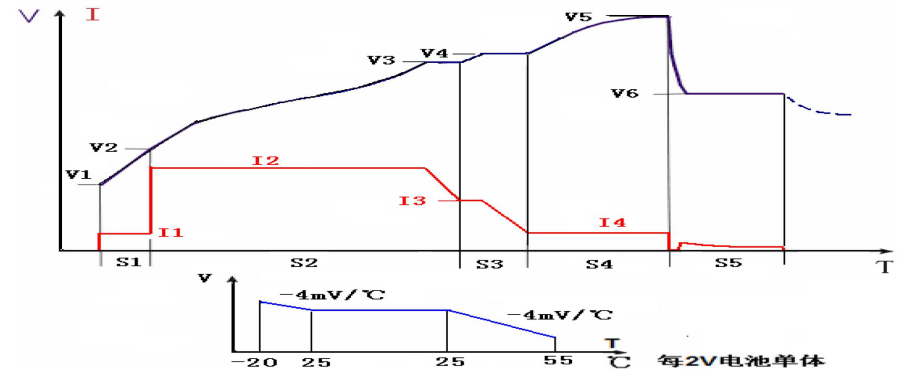

current charging I1, finally, the pre-charging process is completed when voltage rises to U2.

② CC Charging: It operates in a constant current charging I2, then the CC charging ends when voltage reaches to U3.

③CV Charging: Constant voltage charging with U3, the whole charging process is completed when current reduces to U3.

**2). Different brand-name of lead-acid batteries have different kinds of charging curves.**

Below shows a typical charging curve for Chilwee battery:

## 9. Expansion Function

**Choose the accessories according to the actual needs:**

### 1). Thermal Sensor Interface (for lead-acid battery charger)

Thermal Sensor is recommended to lead-acid battery charger, to detect the temperature of the battery and compensate charging voltage, at the same time to realize the battery overheat protection function. Suggest that the thermal sensor is fixed on the cell of the highest temperature. When the thermal sensor is not easy to install on the battery, you can fix the temperature sensor directly to the position that can detect the environmental temperature. Note that it shall not be affected by heat coming from the charger.

### 2). 12V Output

Charger provides a rating voltage 12V0.2A signal output. Its electrical connections is isolated from the interior circuit of the charger for external application function extension. Note that this 12V with LED indicator output interface are common-grounded. The independent 12V output can supply power for the battery management system. Output 12V-5A.

### 3). LED Output Interface

Charger provides Red, Green two LED interface or Red, Yellow, Green three LED interface. Its electrical connections is isolated from the interior circuit of the battery charger for external application function extension.

**4). ENABLE Signal (for Lithium battery charger): External control circuit must be independent circuit**

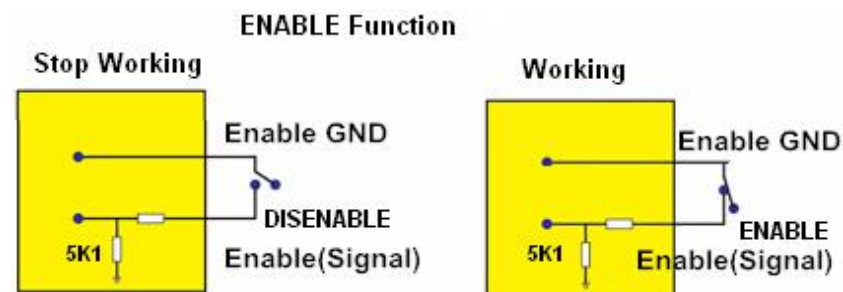

As for lithium battery charger, it's essential to use an enable signal to control the charger's work or close. Isolated circuit (such as Relay or Optocoupler) shall be adopted to control the charger's work or close. Note that if the control circuit is not independent, it lead to damage of the charger.

### 5). Charging Lock up Signal(for lead acid battery)

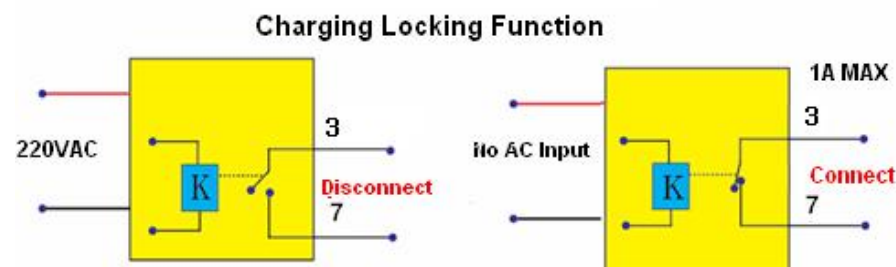

Charger provides a set of relay normally closed contact as charging locking signal output. When the charger has no electricity, the contact connects, while the charger connects to the AC power supply, the contact disconnects immediately. The rated current of contact is 1A, withstand voltage 30VDC / 250VAC.

## 10. Appearance Requirements

- 1). Outer surface should be smooth without obvious defects such as scratch, deformation. Surface coating should be uniform.
- 2). The nameplates and signs should be installed firmly with the neat handwriting.

3). Spare parts should be fastened reliably without rust, burrs, cracks and other defects and damage.

4). Each product should be marked with product identification in obvious place, including part number, product brand, product type, production number, name of production enterprises, the warning message, etc

## 11. Packaging, Transport and Storage

### 1). Packaging

On the packing box, there are product name, product part number, product brand, product type, production number and name of manufacturer; In packing box, along with the technical documents, it includes packing list, quality certificate, product specification.

### 2). Transportation

Suitable for cars, boats, aircraft, transportation. The products have to be prevented against sunshine and moisture and in a civilized transportation.

### 3). Storage

Product should be stored in the packing box when it is not used and be maintained in a 5 °C to 40 °C clean, dry and well-ventilated environment. It should not be stored together with chemicals, acid and alkali substances etc,. Should avoid storing in the sun, fire, water and avoid storing with corrosive substances. The storage period is 2 years (from the inventory date of the factory). After the 2 years of storage period, the products should still comply with the provisions of the relevant standards.

